

Catalogue

1. Safety tips.....	3
2. General introduction.....	4
3. Electrical diagrams.....	4
4. Main Parameter.....	5
5. Installation.....	6
I . Power Input Cable.....	6
II . Power Output Cable.....	6
III. Installation of Wire Spool.....	6
6. Operation.....	7
I . Operation Way.....	7
II . Setup of the Welding Current.....	7
III. Welding Parameter List. (For Low-carbon Steel).....	7
IV. Setup of Welding Speed.....	8
V . Setup of Dry Extension of Welding Wire.....	8
VI. Setup of CO2 Flow.....	8
7. Attention.....	8
I .Work Environment.....	8
II . Safe tips.....	8
8. Maintenance.....	9
9. Fault and repair.....	10
I .Welding Power Supply.....	10
II .Welding Torch.....	10
III.Wire Feeder.....	11
IV.Power Output Cable.....	11

PROMISE

We make a solemn promise: The machine is produced under Chinese & International quality standard, accord with IEC60974-1 International safety standard. The design & technology of the products are protected by patent. The products are guaranteed for one year from purchase date. Please read user manual carefully before operation.

1.Safety tips

During the welding process, the work may cause some damage to you and other people, so please make some protection. For more details, please kindly read “operator safety manual” accord with accident prevention of manufacturer

Worker must receive professional training before operation!

- Use welding safety products recognized by national safety ministry of supervision.
- Worker must be the special operator with valid certificate of metal welding work.
- During maintenance & repair, please disconnect the line of electricity.

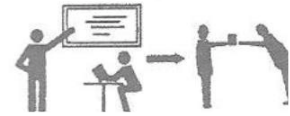

Electric shock: it may cause some injure and even fatal.

- Connect the earth cable according to standard regulation.
- Avoid all contact with live components of the welding circuit, electrodes and wires with bare hands.



- The operator should keep the work piece & earth insulating from himself/herself.
- Make sure the work place on safe situation.



Smoke-may be bad for people’s health.

- Keep your head out of smoke & welding gas in order to avoid breathing it.
- Keep the working area in good ventilation during welding.



Arc light emission: harmful to people’s eyes & skin.

- To protect your eyes and body, please wear welding helmet, work clothes & gloves.
- People in or near the working area should be protected under welding helmet & other protection equipment.



Fire or explosion hazard may be caused by misoperation.

- Welding fire flame may cause fire, please keep the inflammable substance far from workpiece and keep fire safety.
- Make sure fire extinguisher nearby with a professional fire worker here, who can be skillful with fire extinguisher.
- Don’t weld the closed container.



Don’t use this machine for pipe unfreeze.

Hot work piece may scald your hand.

- Don’t contact the hot work piece with bare hand.
- During welding continuously for a long time, the welding torch should have some time to release hot.



Magnetic field will affect heart pacemaker.

- The heart pacemaker user will keep far away from welding area before having some inquiry from doctor.

Moving component will cause some damage to people.

- Keep away from moving component, such as fan.
- Keep the panel, back plate, cover and protection equipments fasten on machine



Fault—you should look for some help from professional worker when you face some trouble.

- If you face some trouble on installation and operation, please check the machine according to the operation manual.
- After your reading on operation manual, still can’t understand something or can’t solve the trouble, Please should contact with your supplier or our company service center for professional help.



2. General introduction

MIG/CUT /MMA/LIFT TIG Welding Machines are manufactured based on the internationally advanced inverter technology. The working principle is to invert 50/60Hz alternative current into direct current first. Then the direct current is inverted into high frequency alternative current (20KHz) by IGBT components before it is rectified.

Machines in this series have features as follow:

- ★ IGBT Inverter technology, current mode control. Reliable quality and stable performance.
- ★ Closed circuit feedback with constant voltage output. Good resistance to voltage fluctuation. ($\pm 15\%$)
- ★ Electric reactor control, stable welding process with little splash, deep welding pool and beautiful welding seam.
- ★ Slow wire-feeding for arc start and tip ball removing after welding ensure high success rate of arc start.
- ★ Suitable for welding thin and medium metal sheet of above 8mm thickness.
- ★ Small measurement, light weight, easy operation, practical and economical.
- ★ The efficiency of this machine is above 85%. It saves above 30% energy compared with the conventional welding machines.

3. Electrical diagrams

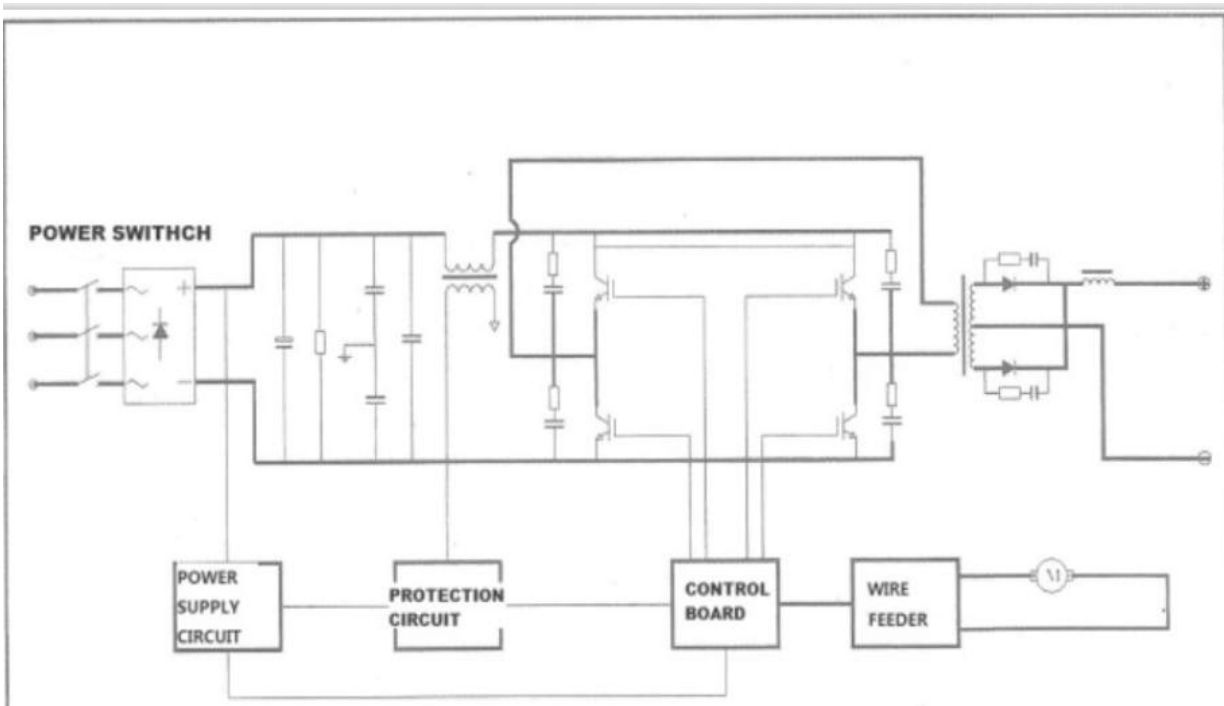

4. Main Parameters

TYPE: TL-520			S/N:							
			IEC 60974-1							
		MIG	30A/15.5V-160A/22V							
		MMA	20A/20.8V-160A/26.4V							
		TIG	20A/10.8V-160A/16.4V							
		CUT	20A/88V-40A/96V							
	U_0 58V		MIG		MMA		TIG		CUT	
		X	60%	100%	60%	100%	60%	100%	60%	100%
	U_1 220V	I_2	160A	123A	160A	123A	160A	123A	40A	30A
		U_2	22V	20.1V	26.4V	24.9V	16.4V	14.9V	96V	92V
		$I_{1\ max}= 29A$				$I_{1\ eff}= 16A$				
IP21S			Air Cooling							

5. Installation

I . Power Input Cable

Each machine is equipped with power input cable. Connect the cable to AC Single phase 110/220V±10% power supply.

II . Power Output Cable

Connect the CO₂ gas bottle firmly with the CO₂ inlet on the back of the welding machine by gas-carrying hose. A gas regulator for the CO₂ gas bottle is needed.

1) Using **CO₂/MIG,MAG** functions, please plug joint into socket and earth clamp into socket, plug the welding torch into the on the front panel and screw it tight. Meanwhile, insert the welding wire into the welding torch by hand from built in wire feeder.

2) Using **Gasless** function,connect, please plug joint into socket and earth clamp into socket,plug the welding torch into the on the front panel and screw it tight. Meanwhile, insert the welding wire into the welding torch by hand from built in wire feeder.

3) Using **MMA and TIG LIFT** functions,plug electrode holder into and earth clamp into .

4) Using **CUT** functions,please plug earth clamp into plug,the CUT touch into

III. Installation of Wire Spool

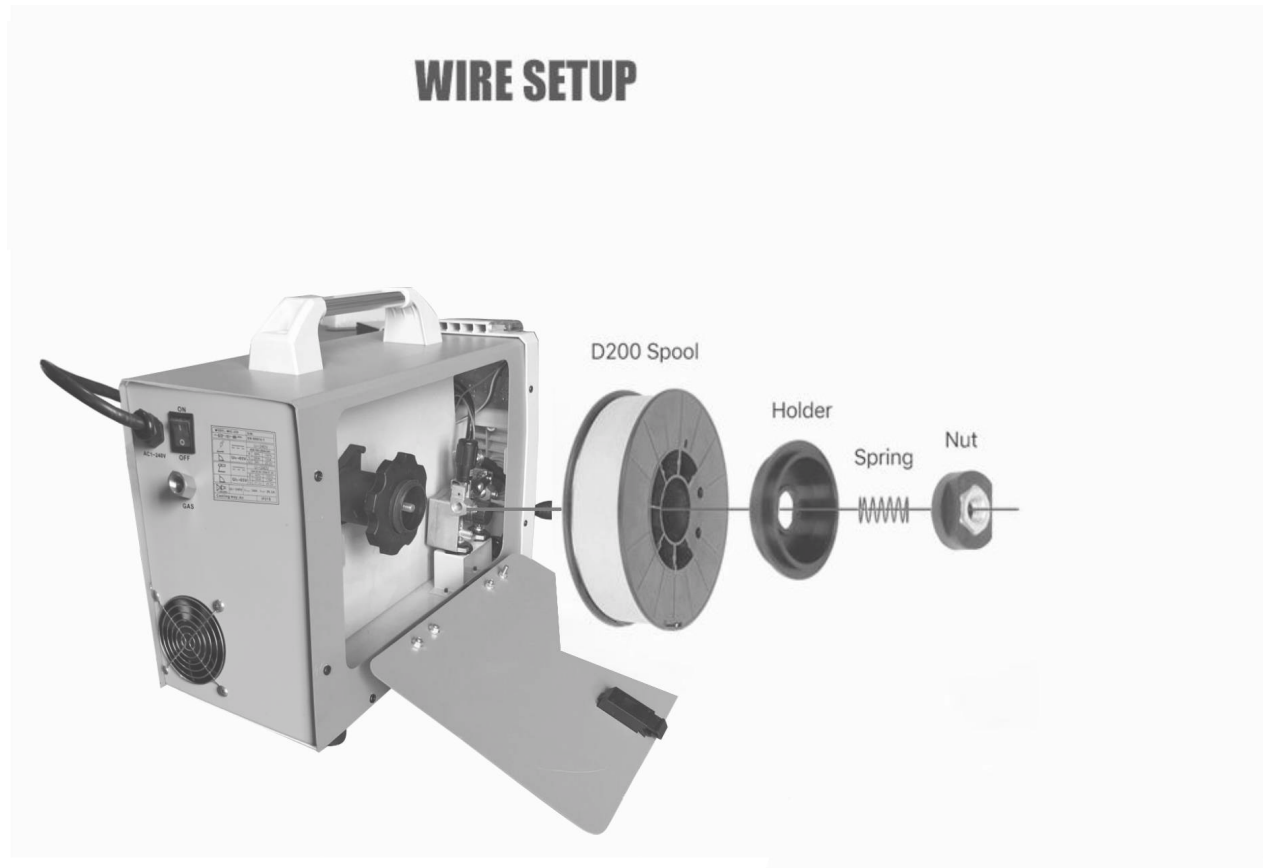

- 1). Mount the wire spool with welding wire to the shaft of wire feeder. Lock the wire spool with the spool holder.
- 2). Choose a suitable contact tip according to the size of welding wire.
- 3). Undo the screw of the wire pressure-wheel and lead the wire into the groove of wire driving wheels via the wire guide tube. Adjust the pressure wheel to ensure no slippage of wire occurs. But too much pressure would cause deformation of welding wire and affect the wire feeding speed.
- 4). Release the welding wire roll by counter clock-wise direction. The head part of the welding wire is always inserted into the fixing bore on the rim of wire spool to ensure avoid the looseness of wire. So please just cut the bent head part off while using in order to avoid wire stuck.
- 5). Choose the correct track of the wire feeding groove by the welding wire diameter.



- 6). Press the “” button to lead the wire out of the welding torch.

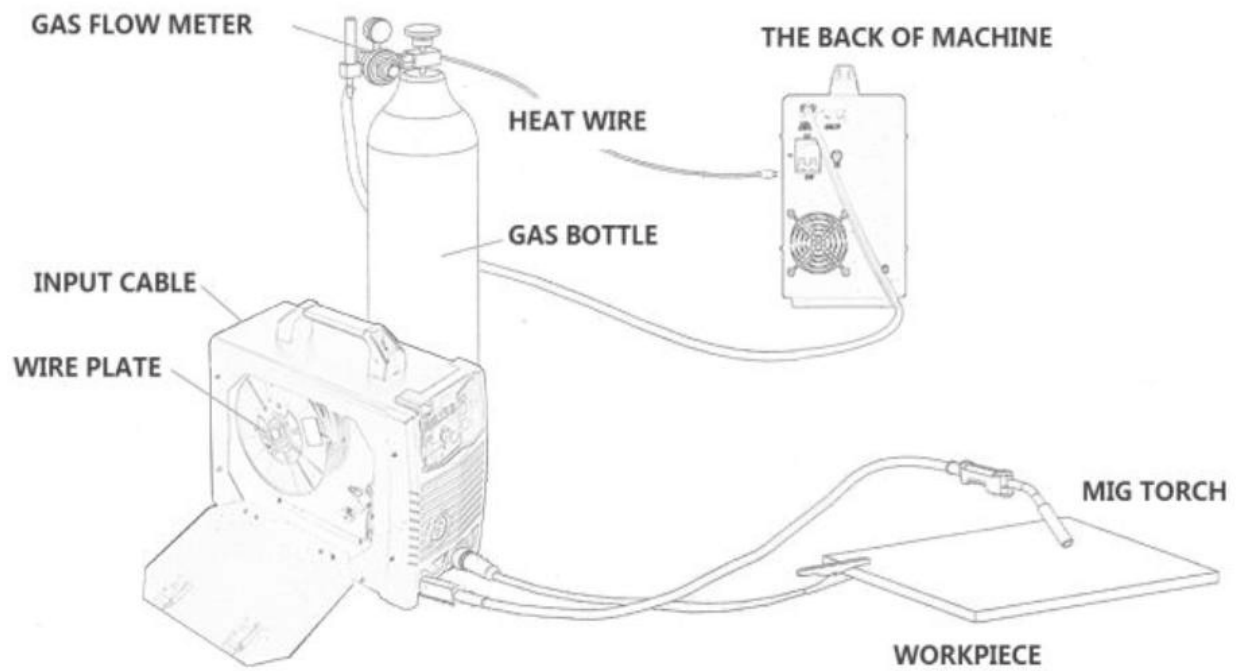

WELDING PERFORMING

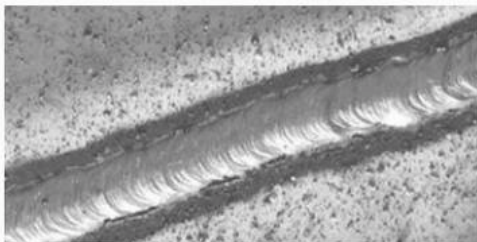

MMA welding performing

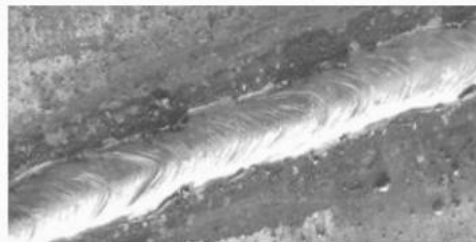

Ø3.2 & Ø4.0mm electrode thickness 5mm flat welding



4mm carbon steel plate angle welding performing



220V 6mm steel plate angle welding

IV. Including Accessories

- 3 meters MIG torch 15AK
- 4 meters cutting torch Pt31
- 4 meters LIFT TIG torch WP-17V
- 3meters cable+electrode holder
- 3 meters grounding cable+clamp
- Gas hose
- Brush
- Manual

6. Operation

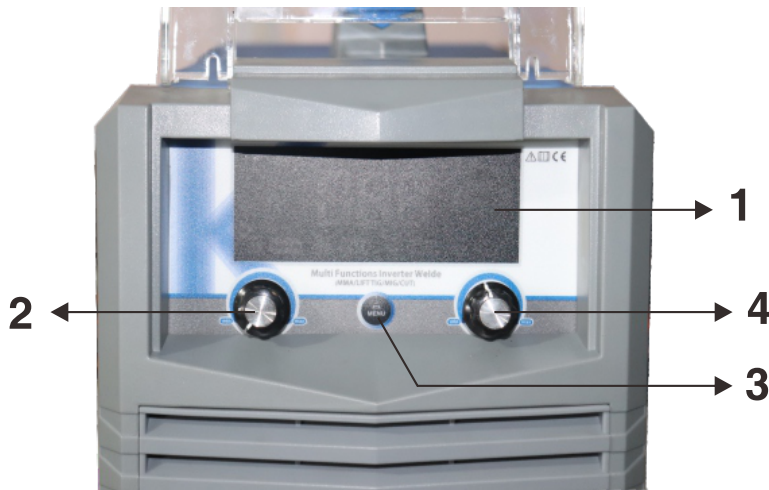

- 1 Displaying Screen
 - 2 Left Adjustment Knob: press to get back to adjustment; scroll to adjust the current; press and hold to enter high-speed wire feeding mode
 - 3 Home Button: press to get back to the home screen
 - 4 Right Adjustment Knob: scroll to adjust selection or fine adjust the voltage; press to select
- Mode Selection: MIG, TIG, MMA (STICK), PLASMA CUT
 - Synergic MIG Mode: welding voltage fine-adjusting -5V ~ +5V; wire feed speed can not be adjusted (automatically fitted by welder data)
 - Welding Materials Selection: 100% CO₂ Fe (Carbon Steel), 75% Ar & 25% CO₂ Fe (Carbon Steel / Stainless Steel), Flux Wire (Carbon Steel)
 - Adjustment Knob: press the knob to enter/select
 - Wire Diameters: solid wire .031"/.039"; Flux wire .031"/.039"

III. Welding Parameter List. (For Low-carbon Steel)

LIFT TIG	Material	Shielding Gas	Tungsten Diameter	24ga. (0.6mm) Amps.	22ga. (0.8mm) Amps.	20ga. (1.0mm) Amps.	18ga. (1.25mm) Amps.	17ga. (1.5mm) Amps.	14ga. (2.0mm) Amps.	1/8" (3.0mm) Amps.	5/32" (4.0mm) Amps.
		Stainless Steel, Steel	Ar(99.9%) DCEN	1.6 / 1/16"	20	25	30	80	100	140	-
			2.0 / 5/64"	-	-	30	80	100	140	180	200
			2.4 / 3/32"	-	-	30	80	100	140	180	200

MMA	Material	Electrode Type	Electrode Diameter	17ga. (1.5mm) Amps.	14ga. (2.0mm) Amps.	1/8" (3.0mm) Amps.	5/32" (4.0mm) Amps.	13/64" (5.0mm) Amps.	1/4" (6.0mm) Amps.
		Stainless Steel, Steel	Acidic Electrode	3/32" (2.4mm)	30	80	100	-	-
	1/8" (3.2mm)			-	80	100	140	-	-
	5/32" (4mm)			-	-	100	140	180	200
	3/16" (5mm)			-	-	100	140	180	200

MAG CO₂ 80% Ar 20% Ar 100%		Solid Wire	.031" 0.8mm	.039" 1.0mm	.059" 1.5mm	.078" 2.0mm	.118" 3.0mm	.157" 4.0mm	.196" 5.0mm	.236" 6.0mm	.275" 7.0mm
	Welding Current A	.031"(0.8mm)	40	75	118	154	160	170	180	190	200
		.039"(1.0mm)	40	75	118	154	160	170	180	190	200
MIG CO₂ 100%		Solid Wire	.031" 0.8mm	.039" 1.0mm	.059" 1.5mm	.078" 2.0mm	.118" 3.0mm	.157" 4.0mm	.196" 5.0mm	.236" 6.0mm	.275" 7.0mm
	Welding Current A	.031"(0.8mm)	40	55	99	125	145	166	180	190	200
		.039"(1.0mm)	40	55	99	125	145	166	180	190	200
	Welding Voltage V	.031"(0.8mm)	13.9	14.8	16.8	18.0	19.0	22.0	23.5	24.0	25.0
		.039"(1.0mm)	15	16.0	18.0	19.0	21	22.0	23.0	23.5	24.5
FLUX WIRE No Gas		FLUX Wire	.039" 1.0mm	.059" 1.5mm	.078" 2.0mm	.098" 2.5mm	.118" 3.0mm	.157" 4.0mm	.196" 5.0mm	.236" 6.0mm	.275" 7.0mm
	Welding Current A	.031"(0.8mm)	63	94	115	150	176	180	185	190	200
		.039"(1.0mm)	63	94	115	150	176	180	185	190	200
	Welding Voltage V	.031"(0.8mm)	14.0	15.6	16.6	16.9	17.0	18.0	18.5	19.5	20.5
		.039"(1.0mm)	14.5	15.3	16.3	16.5	16.8	17.4	18.0	19.0	20.0

PLASMA CUT	220V			
	Output Current	20A-45A		
	Nozzle	.045"		
	Metal Thickness	25/64"	5/8"	25/32"
	AMPS	40	40	40
	PSI	58-65	58-65	58-65
	Speed (mm/min)	500	350	150

7.Attention

I .Work Environment.

- (1) The environment should be dry and the air humidity didn't exceed 90%.
- (2) Temperature should be from -10°C to 40°C.
- (3) Avoid welding under rain or hot sunshine, don't let water or rain into machine.
- (4) Don't work under dust area or aggressive fume.
- (5) Avoid using the machine under strong air flow.

II . Safe tips.

The machine is equipped with over voltage, over current and overheat protection device. If the voltage, output current

and temperature exceed the standard, the machine will stop working. Besides, overusing the machine based on

exceeded voltage, the machine will be damaged, so please kindly note as below:

(1). Ensure Good Airiness.

During the working, the machine will generate high temperature and it needs help from fan to cool the machine. So users please make sure the ventilation inlet is not stuck or covered. Meanwhile, keep the objects

around the machine in a distance of no less than 0.3m. Keeping airiness helps to lower the temperature more quickly and ensures a longer service life of the machine.

(2). Current Overloading Prohibited

Close attention should be paid to the permissible loading current(the available duty cycle) to ensure the welding current being under maximum permissible current. Current overloading shortens service life of a machine greatly, or even damages the machine.

(3). Voltage Overloading Prohibited

For the power supply voltage, please refer to the “Main Parameter Table”. Under normal circumstances, the auto-compensation circuit in the machine will help to keep the welding current within permissible range.

Voltage overload damages the machine, so preventive measures are needed.

(4). Earth cable connects to the ground. There is a mark near the earth screw on the back panel. Before using the machine, please choose a wire (cross sectional area above 6 mm²) to connect the earth screw to ground to avoid electricity leakage accident and release static electricity.

(5). No overload of the standard rated duty cycle. When it overloads the standard, the machine will stop working due to overheat inside of machine. After stopping and resting for some time, the machine can be started to work again.

8.Maintenance

- 1). Below operation should be done by a professional operator with electrical engineering & safe knowledge and ability qualify certificate. Before opening the machine, please make sure the machine input power wire unconnected to power supply.
- 2). Check junction circuit inside of welding machine on time, make sure all the junction right, stable connector (especially on plug connector or component). If anyone is rust or loose, please get rid of the rust or oxide film by sand paper, and reconnect it and make the connection fastened up.
- 3). Don't be close to electron component (such as fan) inside of machine by hand, hair, and other tools when the machine is energized.
- 4). Get rid of the dust with dry compressed clean air general. If machine work under dense smoke & pollution air, please get rid of the dust every day. The compressed pressure should be in the workable level to avoid component damage.
- 5). Try best to keep the water & water vapor from inside of machine. If the water come into inside of machine, please kindly dry the machine immediately. Then, please test insulation situation of welding machine (including each connections or between connections and shell.) firstly, if ok, please continue to work.
- 6). Check all the cover of welding cable general. Any wear out, please bind up or change it.
- 7). Please keep the welding machine in original package in dry place during long time no using.

9. Fault and repair

In order to optimize the machine's function and ensure a safe working condition, maintenance and troubleshooting is critical. When performing maintenance and troubleshooting, please focus on and check the following parts and points: welding torch, wear of spare parts in the wire feeding device, deformation and gas hole. Clean the dust of some parts or replace it if necessary. To keep the original function of the machine, please purchase the genuine spare parts only from our company.

I .Welding Power Supply

Location	Inspection Key Points	Remark
Front Panel	1. Check the work state and installation of the switch. 2. Check and make sure the power-on indicator works properly.	
Cooling Fan	1.Check whether the fan works properly or there is too much noise.	Checking is needed if abnormal noise or non-rotating is found.
Power Supply	1.Check the unusual vibration or bumming while working 2. Check the peculiar smell while working 3. Check the overheating trace like color change	
Outer Area	1.Check the wear of the gas carrying hose and looseness of connectors. 2.Check the looseness of the shelf and other fastened parts.	

II .Welding Torch

Location	Inspection Key Points	Remark
Nozzle	1.Whether it is installed firmly or the front-end is deformed	It leads to bubbles.
	2.Whether it is attached with some splashes.	It leads to burning of the welding torch.(Application of anti-spattering agent is recommended.)
Contact Tip	1. Whether it is installed firmly	Cause of the damage to the torch thread
	2.Damage of the end, wear or stuck of the bore.	Cause of unstable arc or breaking arc
Conductor Tube	1.Check the size of extrusion part	Replace it when it is less than 6mm long. Too short extrusion may cause unstable arc.(Make it a little longer than the regulated length when replacing.)
	2.Check the consistence of the welding wire diameter and inner diameter of contact tube.	The unsuitability of them may cause unstable arc. Change it into a suitable tub.
	3.Check the bending or extended parts.	Cause of bad wire-feeding or unstable arc. Please replace it.
	4.Check the filth inside the tube and the residue of wire cladding	Cause of bad wire-feeding or unstable arc. Please clean with coal oil or replace it.
	5.Check damage of the tube and wear of the O-shaped ring.	It may cause splash. Please replace the damaged one.
Gas Diffuser	1.Check whether it is inserted in or blocked. Check the suitability if it is purchased from other suppliers.	It may cause bad gas-shield, defect of welding or burning of welding torch and so on. Please handle it properly.

III. Wire Feeder

Location	Inspection Key Points	Remark
Tension Arm	1. Whether it is set at the suitable pressure.	Cause of unstable wire-feeding or unstable arc.
Wire Guide Tube	1. Check the welding wire fragment and powder at the inlet of wire guide tube and the rim of wire feeding wheel.	Clean the fragment. Find out the cause and rectify it.
	2. Check the consistence of the welding wire diameter and inner diameter of contact tube.	Cause of unstable arc, welding wire fragment or powder.
	3. Check the consistence of the inlet center of wire guide tube and the groove center of wire feeding wheel by eyes.	The inconsistency of them may cause welding wire powder and unstable arc.
Wire Driving Wheel	1. Check the consistence of the actual diameter of welding wire and the nominal diameter of wire feeding wheel.	1. It causes wire power, jam of wire feeding tube and unstable arc.
	2. Check the jam of the groove of the wire feeding wheel.	2. replace it if unusual phenomenon is found.
Pressure Wheel	1. Check the stability of rotation, wear of the press plane and the narrowing-down of contact plane.	It causes bad wire-feeding. Furthermore it causes unstable arc.

IV. Power Output Cable

Location	Inspection Key Points	Remark
Cable of Welding Torch	1. Whether the cable of welding torch is bent too much. 2. Check the looseness of the metal connector of the fast coupling device.	1. Cause of bad wire-feeding 2. Too much wire feeded with bent cable may cause unstable arc. So please straighten it while welding.
Cable of Power Output	1. Check the wear and damage of the insulation layer. 2. Check the nudity (Insulation Damaged) and looseness of the cable connection (connector of welding power supply and cable connection to the work piece).	Proper measures of inspection shall be used for body safety and welding stability. Usual inspection-general and simple Regular inspection-thorough and complete
Cable of Power Input	1. Check whether the input and output terminals of distribution box are connected firmly. 2. Whether the fuse is connected reliably. 3. Check the connection of input terminal of the welding power supply. 4. Whether the insulation layer is worn out, damaged or nude.	
Ground Cable	1. Check the circuit break and connection of the earth cable of welding power supply. 2. Check the circuit break and connection of the earth cable of work piece.	To avoid power leakage and ensure safety, general inspection must be performed.